

Base model pictured.
Technical details subject to change without notice.
Various engine and pump material construction options available on request.

Technical DATA Sheet

The **Tru-Flo** Pump range has been designed for mining and contractor companies; tough, compact, high performance pumps. Designed to be manoeuvrable, easy to handle, rugged and extremely reliable with the highest efficiencies possible.

Used extensively throughout the mining industry and by major rental and dewatering contractors, they continue to out perform others every time. The Tru-Flo Pumps are renowned for their solids handling capacity and cost efficient solutions.

Join the ever-growing list of mining companies finding the Tru-Flo pump “the best pumps we have on site”.

FREECALL: 1800 813 677

www.truflopumps.com.au

8-14 Irving Place, Bathurst NSW 2795

FEATURES

- ▶ Extremely low fuel usage
- ▶ Reduced engine sizes
- ▶ Lower maintenance costs
- ▶ Super fast, strong, dry self prime
- ▶ Close coupled via SAE to engine
- ▶ Suction lifts to 28ft (8.5m)
- ▶ Operates in 'snore' conditions
- ▶ Diesel, electric or hydraulic drive
- ▶ Duplex stainless steel impeller & wear parts
- ▶ Simple maintenance
- ▶ Skid or trailer mounted
- ▶ Powered by Caterpillar or Cummins
- ▶ Pump Master™ Control Panel
- ▶ 24 Hour run time minimum
- ▶ 110% Hydrocarbon retention with dual skin fuel tank optional

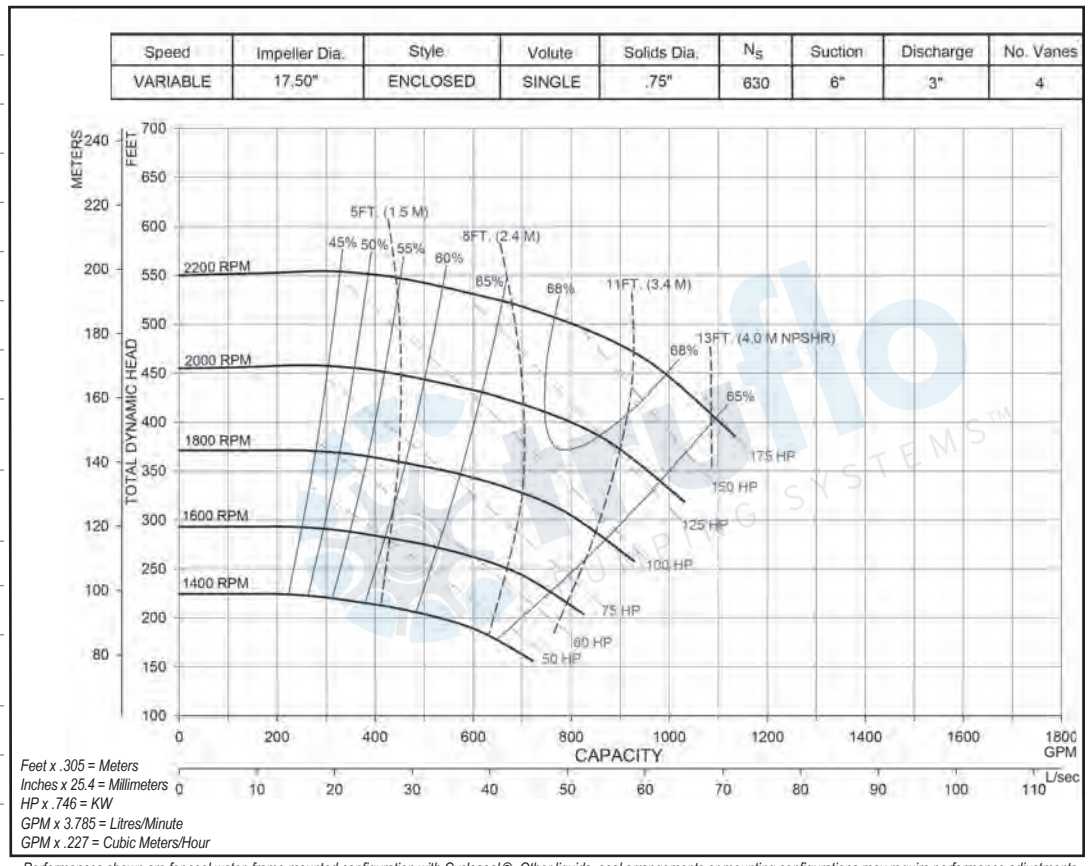

APPLICATIONS

- ▶ Mining
- ▶ Ground dewatering
- ▶ Industrial
- ▶ Quarries
- ▶ Pipeline & drilling
- ▶ Environmental
- ▶ Construction
- ▶ Evaporation projects
- ▶ Sludge & slimes
- ▶ Water transfer

PUMP SPECIFICATIONS	
Suction:	150mm ANSI Flanged (6")
Discharge:	75mm ANSI Flanged (3")
Impeller Design:	17.5" Enclosed
Solids Handling:	18.75mm (.75")
Coupling:	Flywheel, SAE direct flanged
Maximum Operating Temperature:	100°C
Operating Speed:	Min 1400rpm Max 2200rpm
PUMP CONSTRUCTION	
Pump Casing:	Cast Iron
Impeller:	Duplex Stainless Steel
Wear Plate / Ring:	Duplex Stainless Steel
Suction Cover:	Cast Iron
Shaft:	Stainless Steel with replaceable shaft sleeve
Mechanical Seal:	Cycloseal™ Silicon Carbide Run Dry
Bearings:	Double Angular Contact

PUMP PERFORMANCE	
Qmax:	70 L/sec
Hmax:	195 m
PUMP PRIMING SYSTEM	
Vacuum pump type:	Diaphragm
Nominal air capacity:	50 cfm
Max Vacuum:	0.9 bar
Drives:	Belt
CONSTRUCTION SPECIFICATIONS	
Base Type:	B Series Skid
Dry Weight	5600kg
Fuel Capacity:	1500 Litres
Suction Manifold:	150mm Flanged (6") HD Gal
Discharge Manifold:	100mm Flanged (4") HD Gal
Nominal Dimension:	4700 x 1844 x 2875mm
RECOMENDED ENGINE	
Cummins Model:	QSB 6.7
Caterpillar Model:	C7.1 ACERT

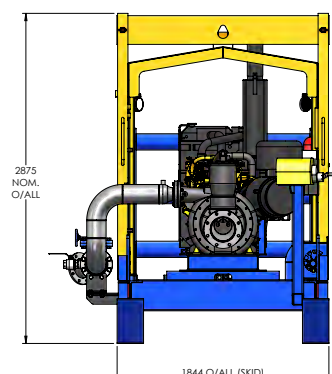
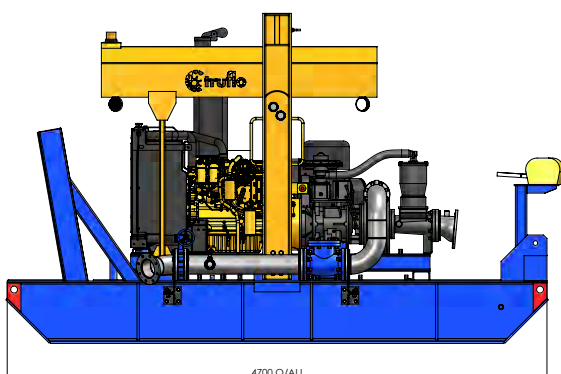

Technical details subject to change without notice.

Various engine and pump material construction options available on request.